

MINI JOLLY EASY DALI

Direct current dimmable electronic drivers with DIP-SWITCH
Alimentatori elettronici regolabili in corrente continua con DIP-SWITCH

Made in Italy 

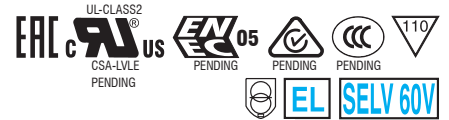
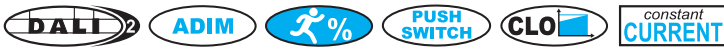

MINI JOLLY EASY DALI

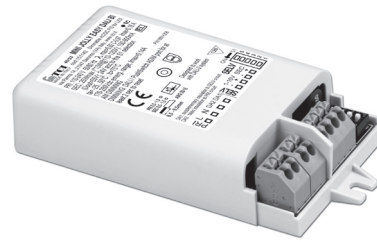

MINI JOLLY EASY DALI BI

3.1.2

Dimmable multipower drivers - Compact case - DALI
Alimentatori multipotenza regolabili - Formato compatto - DALI

Rated Voltage
Tensione Nominale
110 ÷ 127 V⁽²⁾
220 ÷ 240 V

Frequency
Frequenza
50-60 Hz

AC Operation range
Tensione di utilizzo AC
99 ÷ 264 V

DC Operation range
Tensione di utilizzo DC
(see page info15)
176 ÷ 275 V

Power - Potenza
0,3 ÷ 25 W

iTHD
≤ 10%⁽¹⁾

Stand by power
≤ 0,5 W

Output current ripple
≤ 3%⁽¹⁾

Standards compliance
CSA-C22.2 n° 223
CSA-C22.2 n° 250.13
EN 55015
EN 61000-3-2
EN 61000-3-3
EN 61347-1
EN 61347-2-13
EN 61547
EN 62384
EN 62386-101
EN 62386-102
EN 62386-207
EN 62386-251
EN 62386-252
EN 62386-253
UL1310
UL 8750

Max. pcs for CB B16A
(see page info17)
50 pcs

In rush current
5A 50µsec



Article Articolo	Code Codice	P out W	V out DC ⁽¹⁾	I out DC	U out V	ta °C	tc °C	λ max. Power Factor	η max. Efficiency ⁽¹⁾							
MINI JOLLY EASY DALI ⁽⁴⁾	151140	Constant current output - Uscita in corrente costante				59	-25... +45 ⁽⁴⁾ /50	75	0,95 ⁽³⁾	> 86 %						
		8,1 (8,1 ⁽²⁾)	2...54	150 mA cost.												
		10,8 (10,8 ⁽²⁾)	2...54	200 mA cost.												
		13,5 (13,5 ⁽²⁾)	2...54	250 mA cost.												
		16,2 (13,5 ⁽²⁾)	2...54	300 mA cost.												
		18,9 (13,5 ⁽²⁾)	2...54	350 mA cost.												
		21,6 (13,5 ⁽²⁾)	2...54	400 mA cost.												
		24,3 (13,5 ⁽²⁾)	2...54	450 mA cost.												
		25 (13,5 ⁽²⁾)	2...50	500 mA cost.												
		25 (13,5 ⁽²⁾)	2...45,5	550 mA cost.												
		25 (13,5 ⁽²⁾)	2...42	600 mA cost.												
		25 (13,5 ⁽²⁾)	2...38,5	650 mA cost.												
		25 (13,5 ⁽²⁾)	2...36	700 mA cost.												
		25 (13,5 ⁽²⁾)	2...33,5	750 mA cost.												
		25 (13,5 ⁽²⁾)	2...31,5	800 mA cost.												
		25 (13,5 ⁽²⁾)	2...29,5	850 mA cost.												
		25 (13,5 ⁽²⁾)	2...28	900 mA cost.												
		Constant voltage output - Uscita in tensione costante														
		22 (13,5 ⁽²⁾)	24 cost.	900 mA max.	25											

⁽¹⁾ Referred to V_m = 230 V, 100% load - Riferito a V_m = 230 V, carico 100%

⁽³⁾ Pout > 5 W

Light output level in DC operation:

Programmable 1-100% (factory default = 15% EOfi=0.13)

Livello di emissione luminosa in funzionamento DC:

Programmabile 1-100% (impostazione di fabbrica = 15% EOfi=0.13)

Features

- Multipower driver supplied with DIP-SWITCH for the selection of the output current.
- IP20 independent driver, for indoor use (MINI JOLLY EASY).
- Class II protection against electric shock for direct or indirect contact (MINI JOLLY EASY).
- Driver for built-in use (MINI JOLLY EASY BI).
- It can be used for lighting equipment in protection class I and II (MINI JOLLY EASY BI).
- Active Power Factor Corrector.
- Current regulation ± 5 % including temperature variations.
- Input and output terminal blocks on the same side (wire cross-section up to 1,5 mm² / AWG15).
- Clamping screws on primary and secondary circuits for cables with diameter: min. 3 mm - max. 8 mm (MINI JOLLY EASY).
- Protections:
 - against overheating and short circuits;
 - against mains voltage spikes;
 - against overloads.
- Thermal protection = C.5.a.

Caratteristiche

- Alimentatore multipotenza fornito di DIP-SWITCH per la selezione della corrente in uscita.
- Alimentatore indipendente IP20, per uso interno (MINI JOLLY EASY).
- Protetto in classe II contro le scosse elettriche per contatti diretti e indiretti (MINI JOLLY EASY).
- Alimentatore da incorporare (MINI JOLLY EASY BI).
- Utilizzabile per apparecchi di illuminazione in classe di protezione I e II (MINI JOLLY EASY BI).
- PFC attivo.
- Corrente regolata ± 5 % incluse variazioni di temperatura.
- Morsetti di entrata e uscita sullo stesso lato (sezione cavo fino a 1,5 mm² / AWG15).
- Serracavo su primario e secondario per cavi di diametro: min. 3 mm - max. 8 mm (MINI JOLLY EASY).
- Protezioni:
 - termica e cortocircuito;
 - contro le extra-tensioni di rete;
 - contro i sovraccarichi.
- Protezione termica = C.5.a.

The data shown are preliminary and may change - I dati riportati sono preliminari e potrebbero subire variazioni

Direct current dimmable electronic drivers with DIP-SWITCH Alimentatori elettronici regolabili in corrente continua con DIP-SWITCH

Made in Italy

IP 20 **SCREW FIXING** $\varnothing 55$ 2,17" Weight - Peso gr. 106 / 3,7 oz.
Pcs - Pezzi 50



BUILT-IN **SCREW FIXING** Weight - Peso gr. 94 / 3,3 oz.
Pcs - Pezzi 50

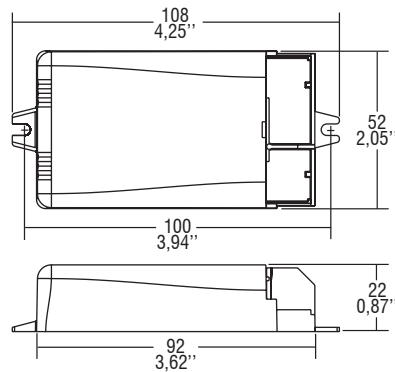

Wiring diagram - Schema di collegamento (Max. LED distance on page info8 - Massima distanza LED a pagina info8)

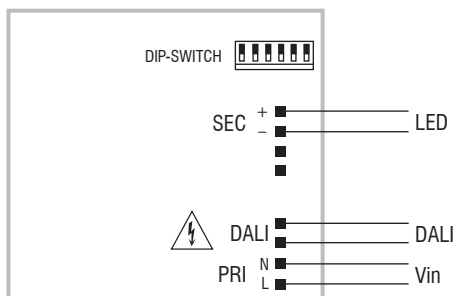

DALI diagram - Collegamento DALI

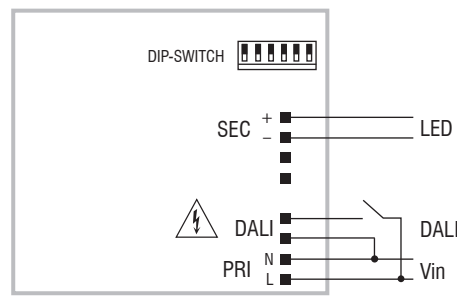

PUSH SWITCH diagram - Collegamento PUSH SWITCH

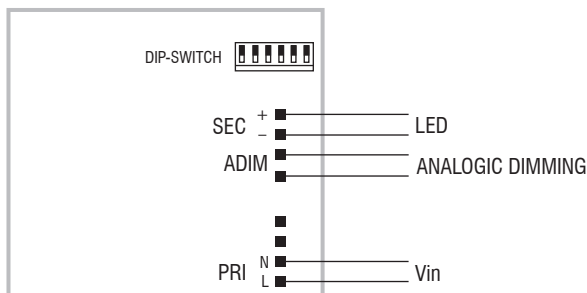

ADIM diagram - Collegamento ADIM

Operation Mode

- Features DALI-2 dimming (0/1 - 100 %, minimum output current 7 mA):
 - memory function for sets or light groups;
 - recall of stored functions;
 - compatible with standard DALI interfaces;
 - CLO;
 - DC EMERGENCY;
 - PUSH-SWITCH (enable/disable);
 - 0/1-10 V setting.
 - **Dimming method is AMPLITUDE.**
 - Light regulation 0/1 - 100 % by means of PUSH SWITCH function (mains voltage):
 - a short push to turn on and off;
 - a longer push to increase or decrease light intensity;
 - regulation automatically stops at minimum and maximum values;
 - for another on, regulation or off command, release the push button and give the desired command again;
 - dimming level memory at mains restore.
 - Light regulation 0/1 - 100 % by means of 0/1...10 V local interface (I=0,35 mA) or 100 Kohm potentiometer.
- For additional details for regulations see pages info12-14.

Modalità di funzionamento

- Caratteristiche della regolazione DALI-2 (0/1 - 100 %, corrente minima d'uscita 7 mA):
 - funzione di memoria per scenari o gruppi luminosi;
 - richiamo di funzioni memorizzate;
 - compatibilità con interfacce DALI standard;
 - CLO;
 - DC EMERGENCY;
 - PUSH-SWITCH (abilitare/disabilitare);
 - Settaggio 0/1-10 V.
 - **La dimmerazione è in ampiezza.**
 - Regolazione della luminosità 0/1 - 100 % mediante la funzione PUSH SWITCH (tensione di rete):
 - una pressione breve per accendere e spegnere;
 - una pressione prolungata per aumentare o diminuire l'intensità luminosa;
 - la regolazione si ferma automaticamente ai valori minimi e massimi;
 - per un nuovo comando accensione, regolazione o spegnimento, rilasciare il pulsante e dare nuovamente il comando desiderato;
 - ripristino del livello di dimming al ritorno alimentazione.
 - Regolazione della luminosità 0/1 - 100 % mediante interfaccia locale 0/1...10 V (I=0,35 mA) o potenziometro da 100 Kohm.
- Per ulteriori dettagli sulle regolazioni vedi pagine info12-14.

3.1.2

Dimmable multipower drivers - Compact case - DALI
Alimentatori multipotenza regolabili - Formato compatto - DALI