



25W Constant Power Mode LED Driver

XLG-25 series



■ Features

- Constant Power mode output
- Metal housing design with functional Ground
- Built-in active PFC function
- Class 2 power unit
- No load / Standby power consumption <0.5W
- IP67 rating for indoor or outdoor installations
- Function options: output adjustable via potentiometer
3 in 1 dimming function (Dim to off and Isolation design)
- Typical lifetime>50000 hours
- 5 years warranty

■ Applications

- LED street lighting
- LED architectural lighting
- LED bay lighting
- LED floodlighting
- Type “HL” for use in Class I, Division 2 hazardous (Classified) location.

■ Description

XLG-25 series is a 25W AC/DC LED driver featuring the constant power mode output. XLG-25 operates from 90~305VAC. Thanks to the high efficiency up to 88%, The entire series is able to operate between -40°C ~85°C wide case temperature range with air convection. The design of metal housing and Ip67 ingress protection level allows this series to fit both indoor and outdoor applications. XLG-25 is equipped with various function options, such as dimming methodologies, so as to provide the optimal design flexibility for LED lighting system. XLG-25 series comply with the latest version of IEC61347/GB7000.1 -2015 and UL8750 international safety regulations. The output and dimming circuit are also completely in accordance with the new regulations with isolation to ensure the safety of both users and luminaire system during installation.

■ Model Encoding

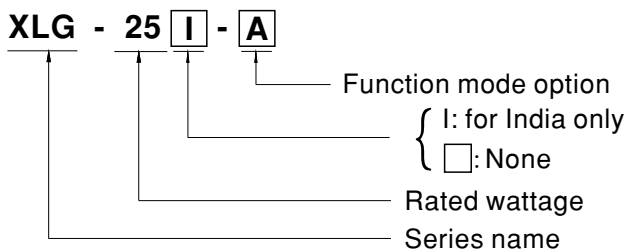

Type	IP Level	Function	Note
A	IP67	Io adjustable through built in potentiometer.	In Stock
AB	IP67	Io adjustable through built in potentiometer 3 in 1 dimming function (0~10Vdc, 10V PWM signal and resistance)	In Stock



SPECIFICATION

MODEL		XLG-25□-□			
OUTPUT	RATED CURRENT	700mA			
	CONSTANT CURRENT REGION <small>Note.2</small>	22 ~ 54V			
	RATED POWER <small>Note.5</small>	90VAC ~ 305VAC			
	CURRENT RIPPLE	25W			
	OPEN CIRCUIT VOLTAGE (max.)	5.0% max. @rated current			
	CURRENT ADJ. RANGE	57V			
	SETUP, RISE TIME <small>Note.3</small>	0.25 ~ 1.05A			
INPUT	VOLTAGE RANGE <small>Note.4</small>	500ms, 100ms/115VAC, 230VAC			
	FREQUENCY RANGE	90 ~ 305VAC (Please refer to "STATIC CHARACTERISTIC" section)			
	POWER FACTOR	47 ~ 63Hz			
	TOTAL HARMONIC DISTORTION	PF ≥ 0.97/115VAC, PF ≥ 0.95/230VAC, PF ≥ 0.92/277VAC@full load (Please refer to "POWER FACTOR (PF) CHARACTERISTIC" section)			
	EFFICIENCY (Typ.) <small>Note.10</small>	THD < 10% (@load ≥ 50%/115VAC, 230VAC; @load ≥ 75%/277VAC) (Please refer to "TOTAL HARMONIC DISTORTION (THD)" section)			
	AC CURRENT	88%			
	INRUSH CURRENT(Typ.)	0.29A / 115VAC 0.15A / 230VAC 0.13A/277VAC			
	MAX. No. of PSUs on 16A CIRCUIT BREAKER	COLD START 50A(twidth=350µs measured at 50% Ipeak) at 230VAC; Per NEMA 410			
	LEAKAGE CURRENT	5 units (circuit breaker of type B) / 8 units (circuit breaker of type C) at 230VAC			
	NO LOAD / STANDBY POWER CONSUMPTION	<0.75mA / 277VAC			
PROTECTION	OVER POWER	No load power consumption <0.5W for A, <0.75W for I series			
	OVER CURRENT	Standby power consumption <0.5W for AB			
	SHORT CIRCUIT	110-150% Over Power Protection, recovers automatically after fault condition is removed			
	OVER TEMPERATURE	Constant current limiting, recovers automatically after fault condition is removed			
	INPUT OVER VOLTAGE <small>Note.8</small>	Constant current limiting, recovers automatically after fault condition is removed			
ENVIRONMENT	WORKING TEMP.	Hiccup mode, recovers automatically after fault condition is removed			
	MAX. CASE TEMP.	320 ~ 370VAC (Shut down output voltage when the input voltage exceeds protection voltage) can survive input voltage stress of 440Vac for 48 hours			
	WORKING HUMIDITY	Tcase=-40 ~ +85°C (Please refer to "OUTPUT LOAD vs TEMPERATURE" section)			
	STORAGE TEMP.	Tcase=+85°C			
	TEMP. COEFFICIENT	20 ~ 95% RH non-condensing			
	VIBRATION	-40 ~ +80°C			
SAFETY & EMC	SAFETY STANDARDS	±0.03%/°C (0 ~ 60°C)			
	WITHSTAND VOLTAGE	10 ~ 500Hz, 5G 12min./1cycle, period for 72min. each along X, Y, Z axes			
	ISOLATION RESISTANCE	UL8750(type"HL"), CSA C22.2 No. 250.13-12: ENEC AS/NZS IEC EN61347-1, AS/NZS EN61347-2-13 independent, EN62384; IP67; GB19510.1, GB19510.14, EAC TP TC 004(for XLG-25l only) approved			
	EMC EMISSION	Parameter	Standard	Test Level/Note	
			Conducted	EN55015(CISPR15)	-----
			Radiated	EN55015(CISPR15)	-----
			Harmonic Current	EN61000-3-2	Class C @load≥50%
			Voltage Flicker	EN61000-3-3	-----
	EMC IMMUNITY	Parameter	Standard	Test Level/Note	
			ESD	EN61000-4-2	Level 3, 8KV air ; Level 2, 4KV contact
Radiated			EN61000-4-3	Level 3	
EFT/Burst			EN61000-4-4	Level 3	
Surge			EN61000-4-5	4KV/Line-Line 6KV/Line-Earth(6K/10K option)	
Conducted			EN61000-4-6	Level 3	
Magnetic Field			EN61000-4-8	Level 4	
Voltage Dips and Interruptions			EN61000-4-11	>95% dip 0.5 periods, 30% dip 25 periods, >95% interruptions 250 periods	
OTHERS	MTBF	1305.62 K hrs min. Telcordia SR-332 (Bellcore) 399.88Khrs min. MIL-HDBK-217F (25°C)			
	DIMENSION	105*63*30mm (L*W*H)			
	PACKING	0.41Kg;24pcs/ 10.5Kg/0.68CUFT for A-type 0.42Kg;24pcs/ 11Kg/0.68CUFT for AB-type			
NOTE	<p>1. All parameters NOT specially mentioned are measured at 230VAC input, rated current and 25°C of ambient temperature.</p> <p>2. Please refer to "DRIVING METHODS OF LED MODULE".</p> <p>3. Length of set up time is measured at first cold start. Turning ON/OFF the driver may lead to increase of the set up time.</p> <p>4. De-rating may be needed under low input voltages. Please refer to "STATIC CHARACTERISTIC" sections for details.</p> <p>5. The driver is considered as a component that will be operated in combination with final equipment. Since EMC performance will be affected by the complete installation, the final equipment manufacturers must re-qualify EMC Directive on the complete installation again.</p> <p>6. This series meets the typical life expectancy of >50,000 hours of operation when Tcase, particularly (Ⓢ) point (or TMP, per DLC), is about 70°C or less.</p> <p>7. Please refer to the warranty statement on MEAN WELL's website at http://www.meanwell.com</p> <p>8. Only for XLG-25 I series</p> <p>9. The ambient temperature derating of 3.5°C/1000m with fanless models and of 5°C/1000m with fan models for operating altitude higher than 2000m(6500ft).</p> <p>10. Only for XLG-25-A</p> <p>11.Products sourced from the Americas regions may not have the CCC logo. Please contact your MEAN WELL sales for more information.</p> <p>12. For any application note and IP water proof function installation caution, please refer our user manual before using. https://www.meanwell.com/Upload/PDF/LED_EN.pdf</p>				



25W Constant Power Mode LED Driver

XLG-25 series

Block Diagram

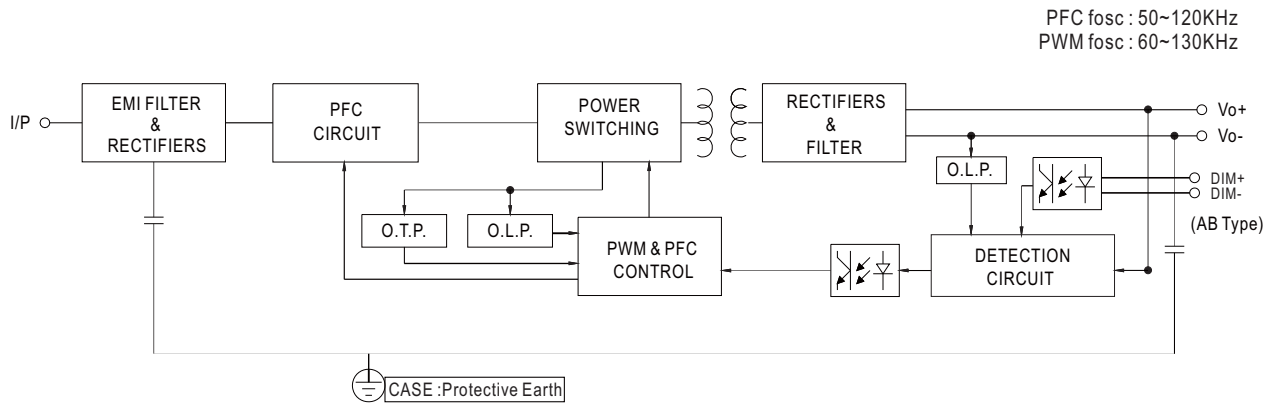

DRIVING METHODS OF LED MODULE

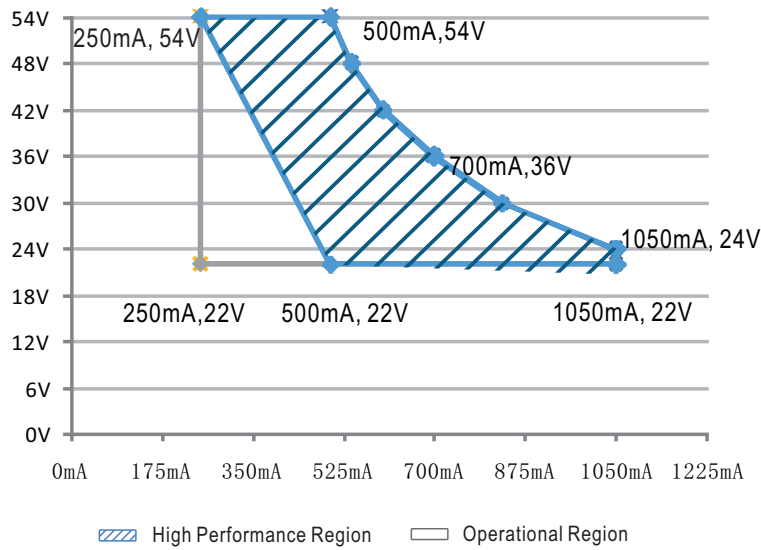



25W Constant Power Mode LED Driver

XLG-25 series

■ DIMMING OPERATION

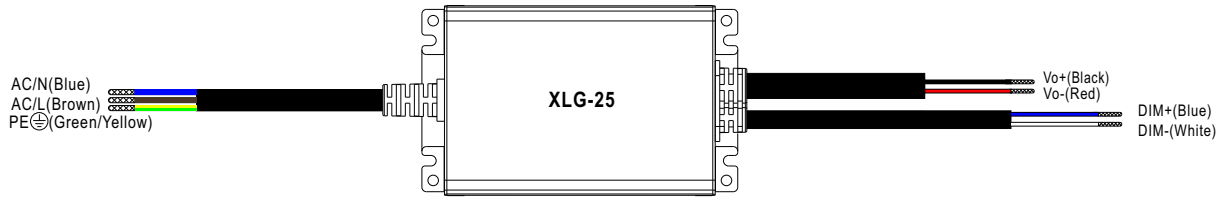

※ 3 in 1 dimming function (for AB-Type)

- Output constant current level can be adjusted by applying one of the three methodologies between DIM+ and DIM-: 0 ~ 10VDC, or 10V PWM signal or resistance.
- Direct connecting to LEDs is suggested. It is not suitable to be used with additional drivers.
- Dimming source current from power supply: 100 μ A (typ.)

◎ Applying additive 0 ~ 10VDC

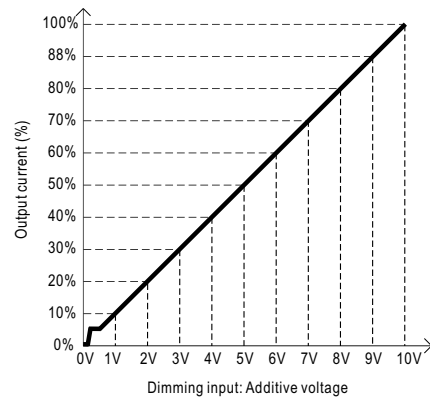
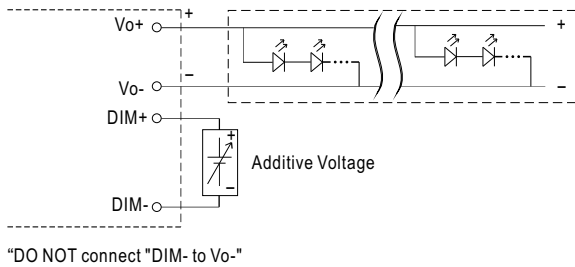

◎ Applying additive 10V PWM signal (frequency range 100Hz ~ 3KHz):

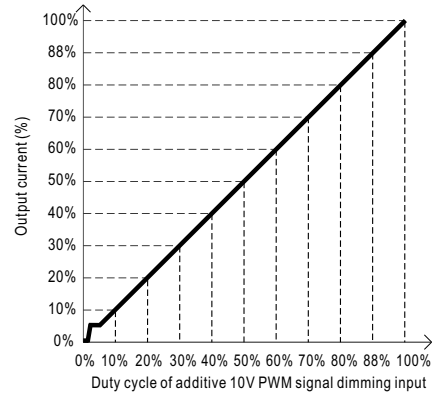
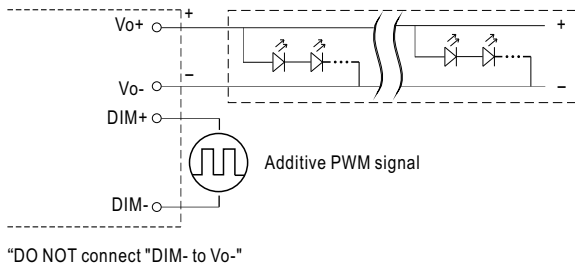

◎ Applying additive resistance:

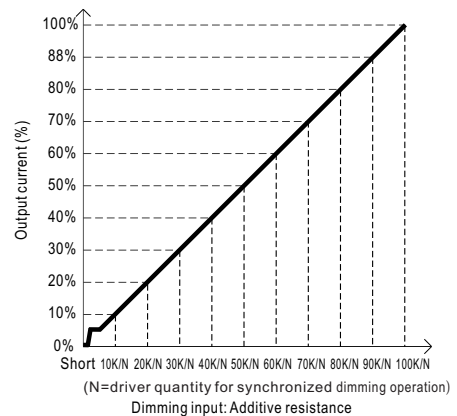
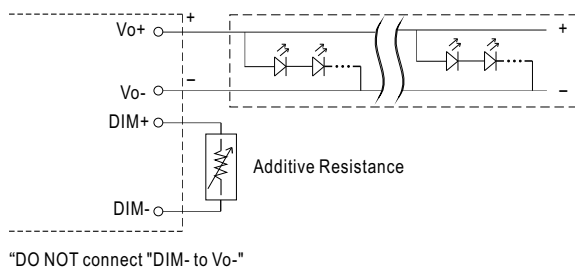

Note : 1. Min. dimming level is about 8% and the output current is not defined when 0% < I_{out} < 8%.

2. The output current could drop down to 0% when dimming input is about 0k Ω or 0Vdc, or 10V PWM signal with 0% duty cycle.



OUTPUT LOAD vs TEMPERATURE

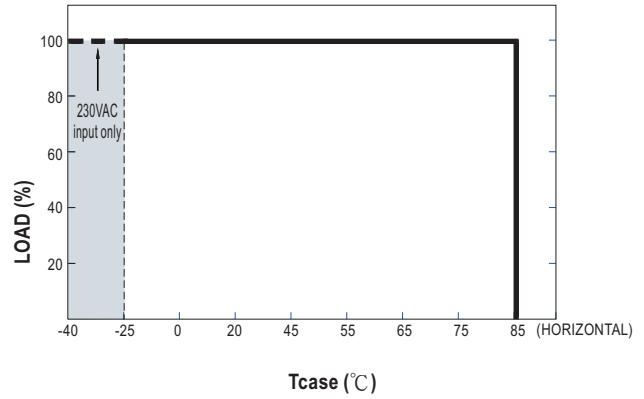
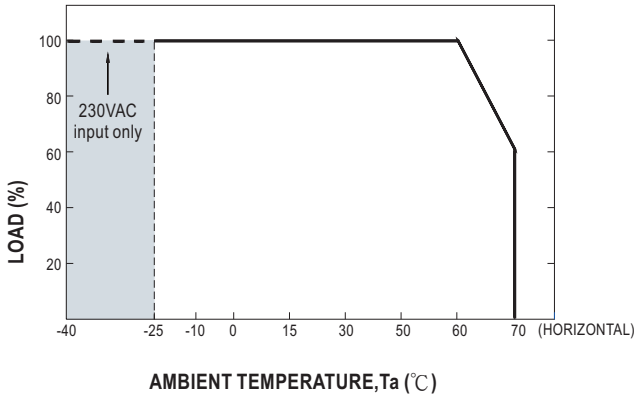

STATIC CHARACTERISTIC

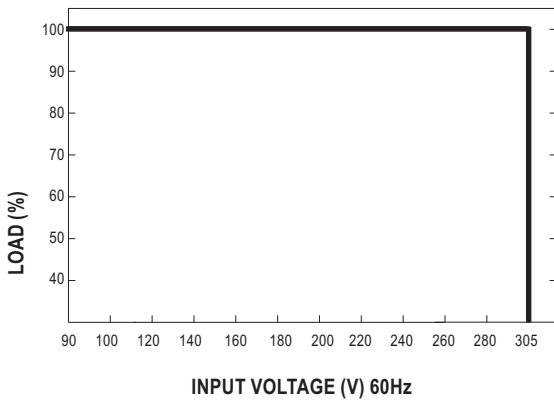

※ De-rating is needed under low input voltage.

POWER FACTOR (PF) CHARACTERISTIC

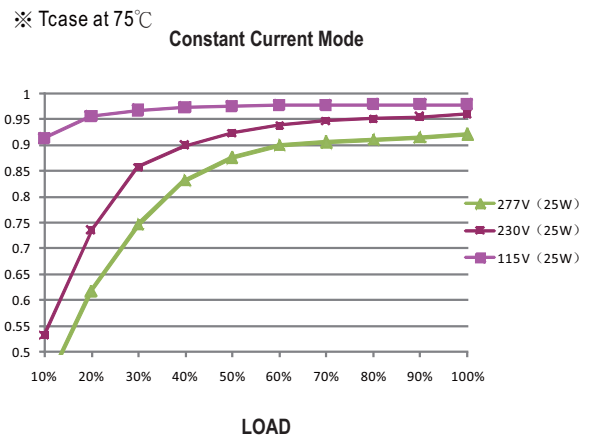

TOTAL HARMONIC DISTORTION (THD)

※ 50V Model, Tcase at 75°C

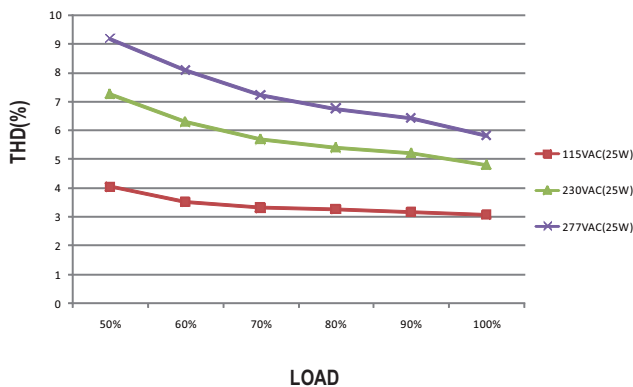

EFFICIENCY vs LOAD

XLG-25 series possess superior working efficiency that up to 88% can be reached in field applications.

※ 50V Model, Tcase at 75°C

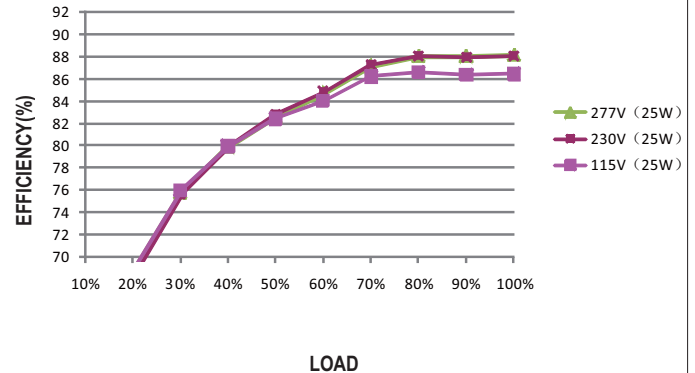



■ LIFE TIME

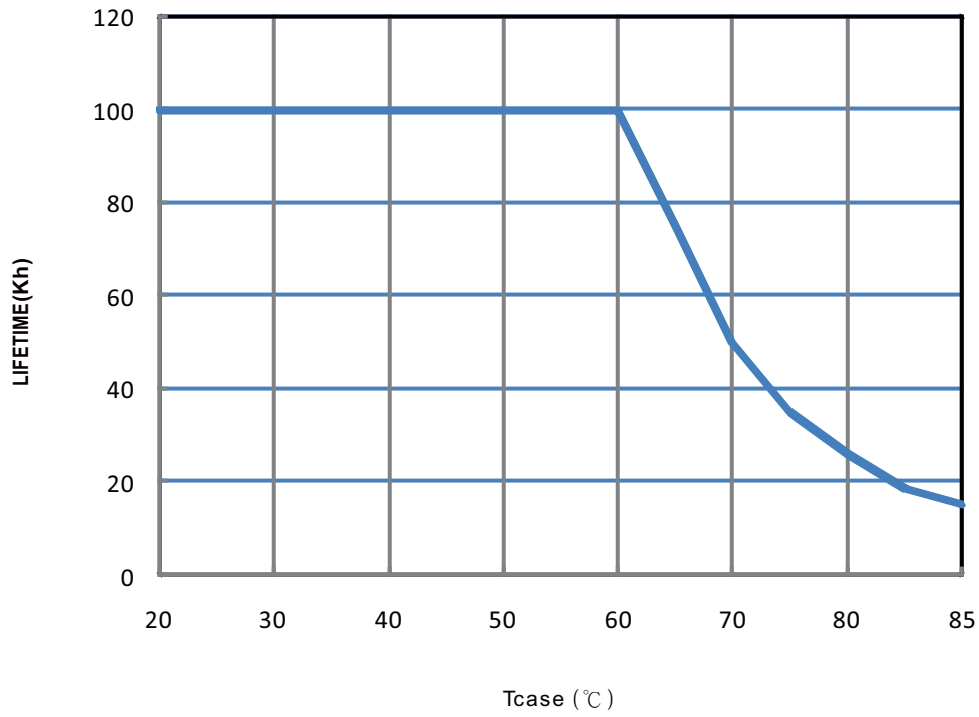



25W Constant Power Mode LED Driver

XLG-25 series

■ Mechanical Specification

※ A-Type

CASE NO.: 268A

Unit:mm

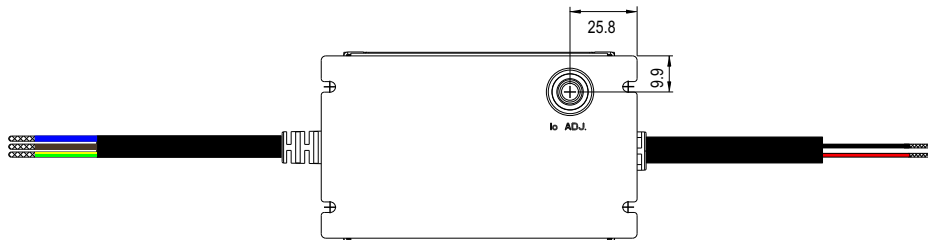
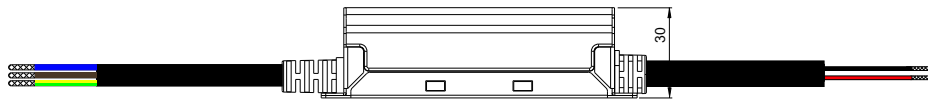
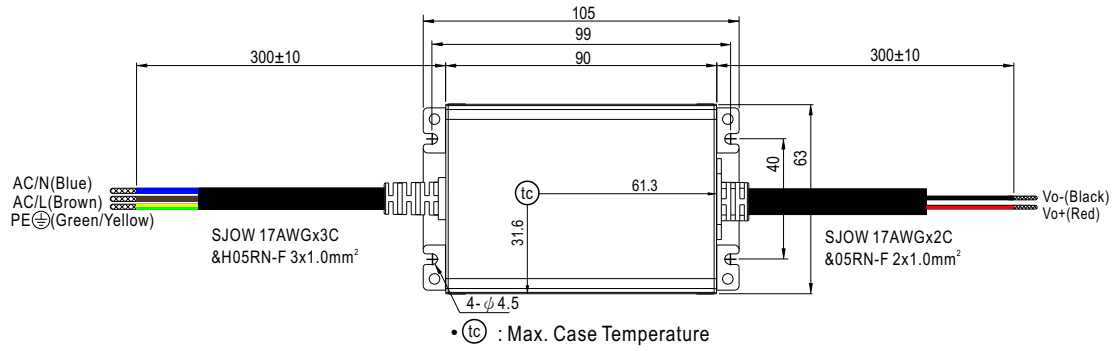



25W Constant Power Mode LED Driver

XLG-25 series

※ AB-Type

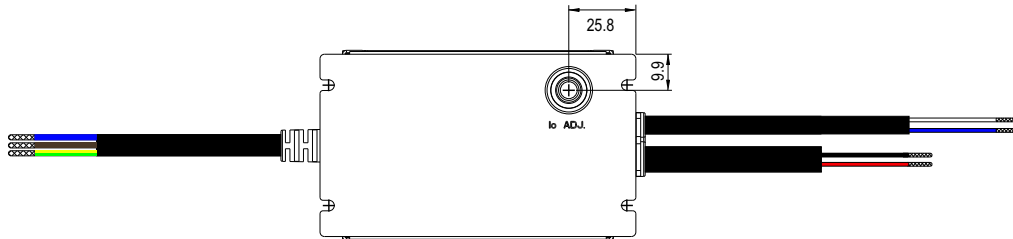
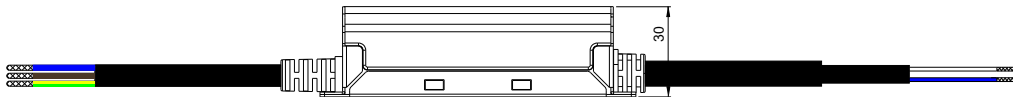
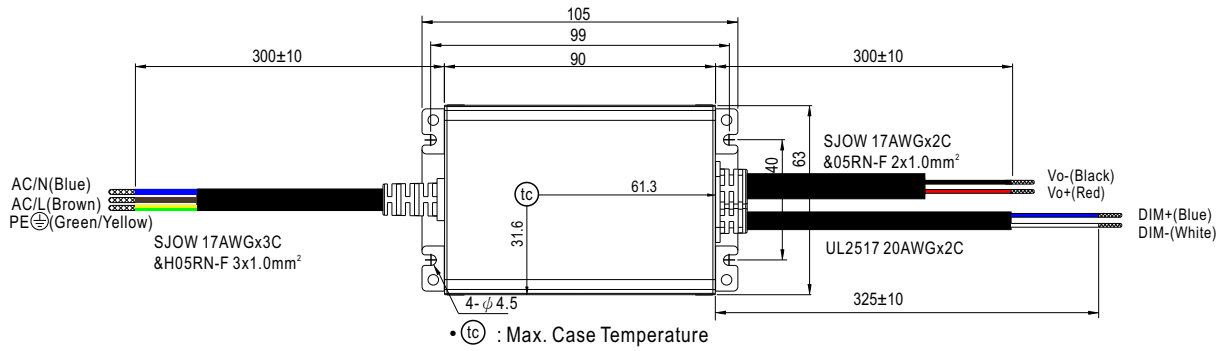

■ Installation Manual

Please refer to : <http://www.meanwell.com/manual.html>